

1:35 '39-'45 SERIES

KIT NO. 6208

# Sd.Kfz. 182 KING TIGER (HENSCHEL TURRET)

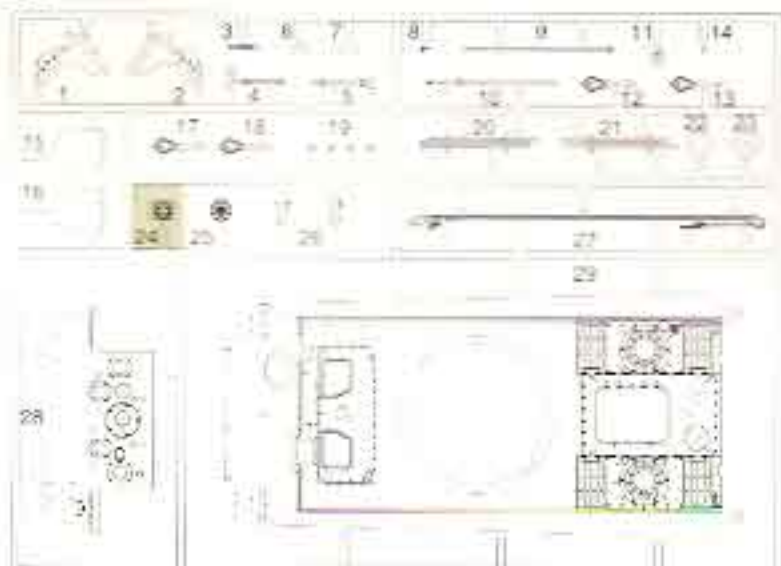
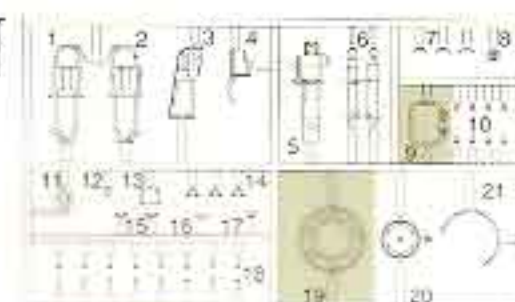
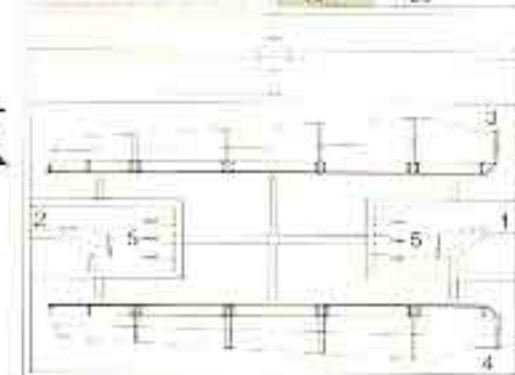
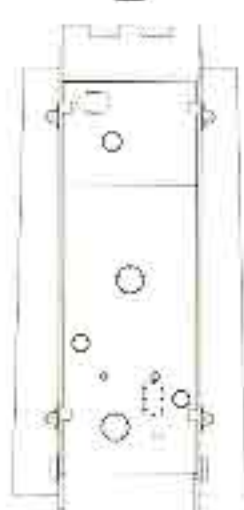
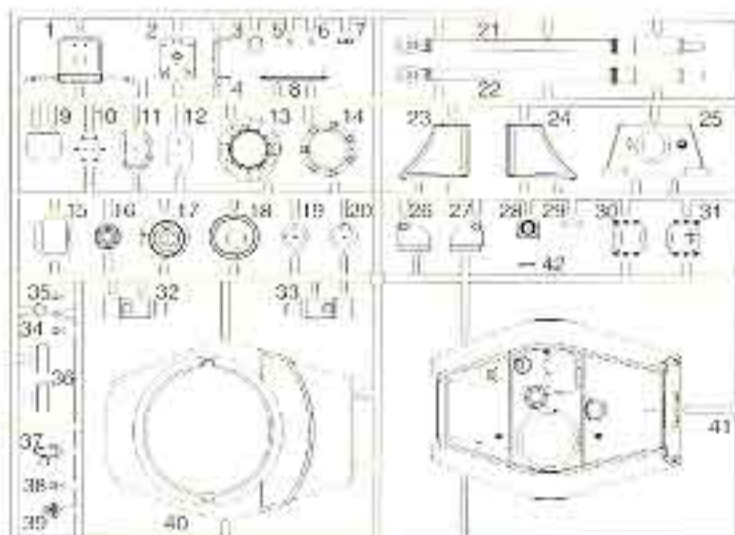
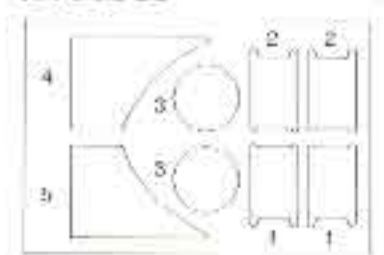

Project supervised by HIROHISA TAKADA. Technical drawings provided by MINORU IGARASHI.

**Ax2****Bx2****C****Gx6****D****S (420mm)****Fx6****N****K****I****O****MA** (Please check Part In Label)



 の部品は使用しません  
 Parts not for use.  
 Teile werden nicht verwendet.  
 Pièces a ne pas utiliser.  
 Partii nin uzatit.  
 不需要使用的部件



**1**

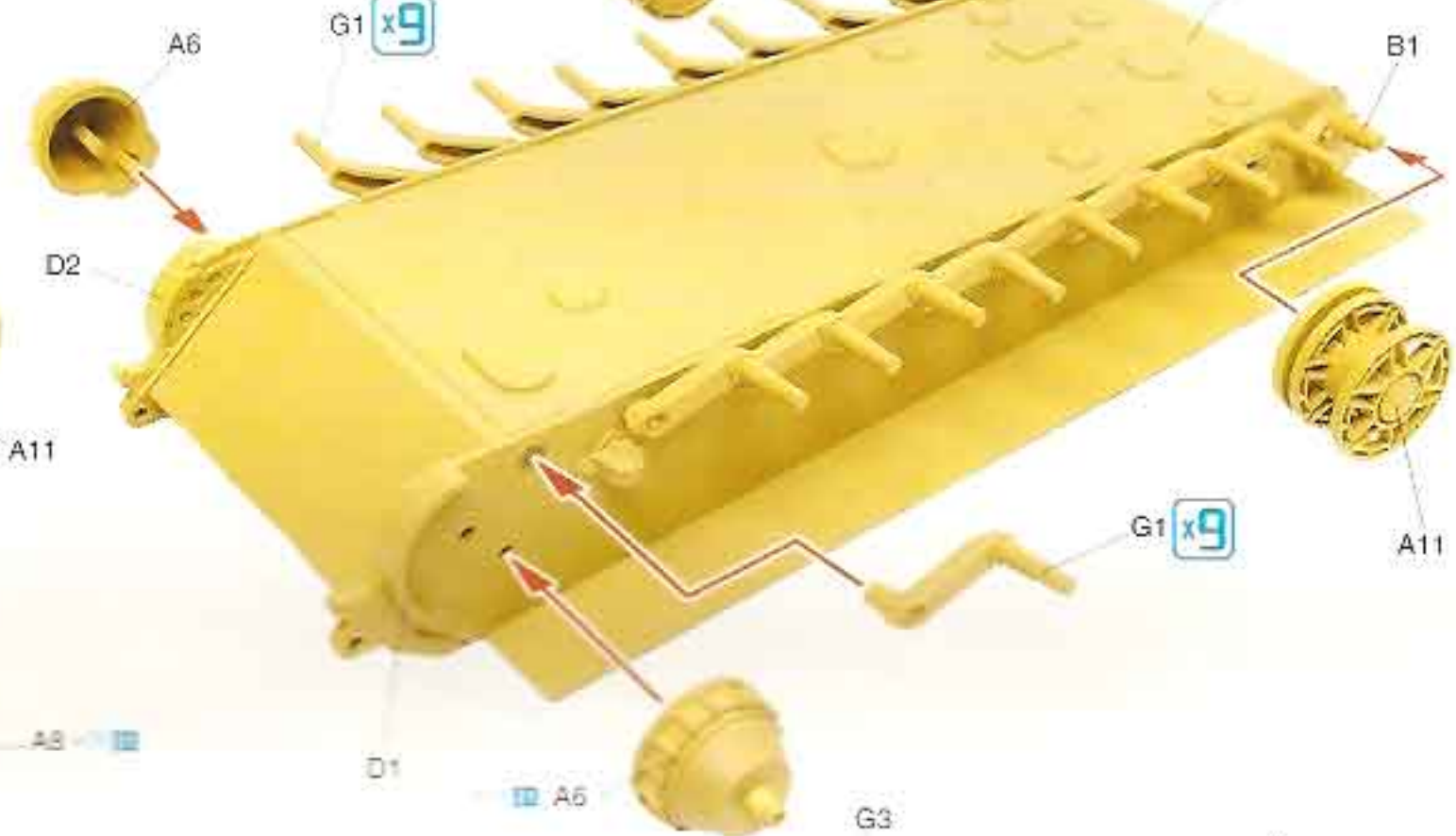

**2**



**3**

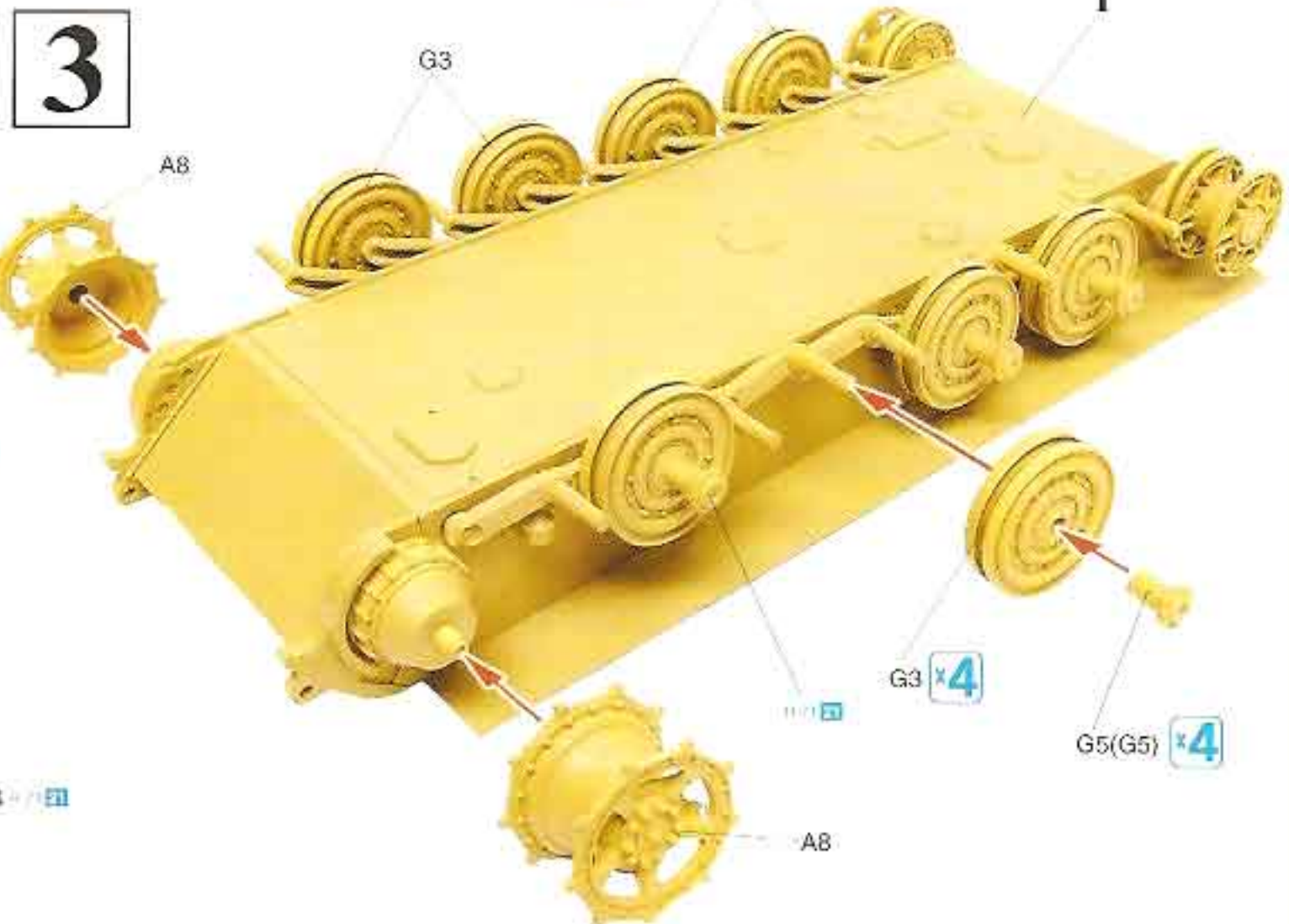

4



5

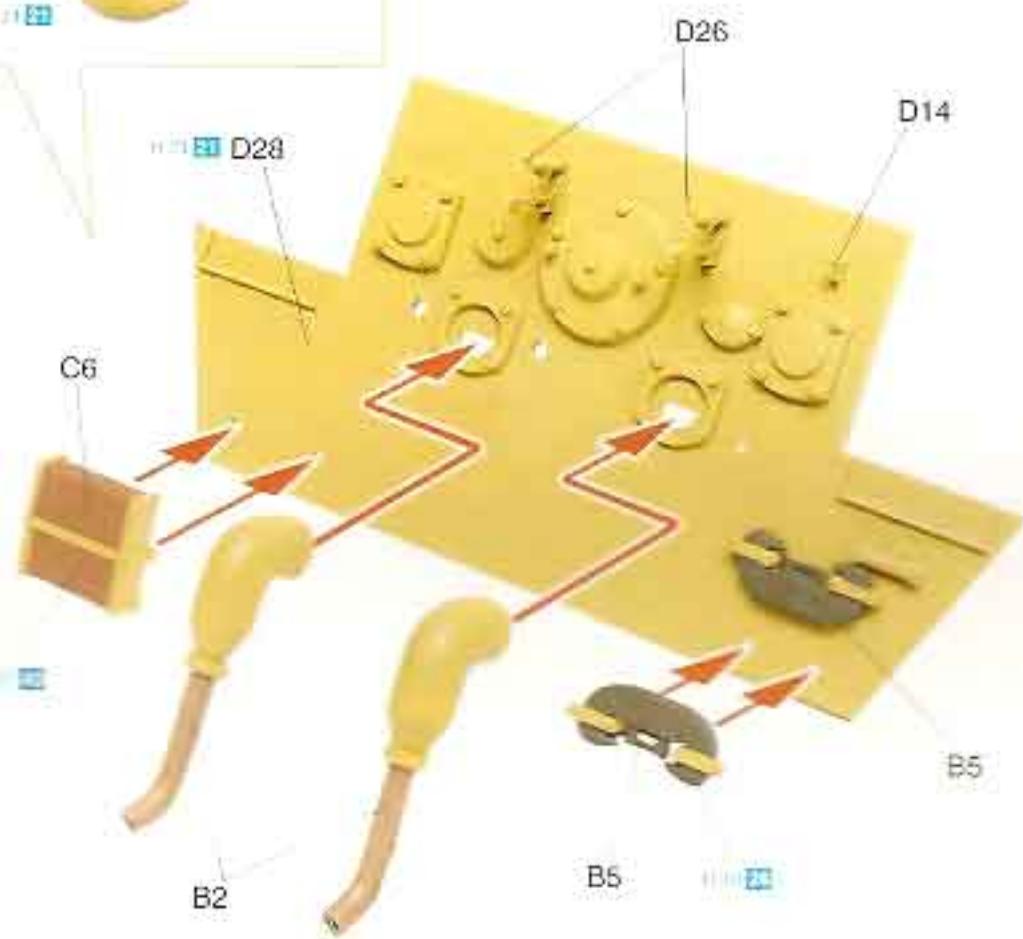

6



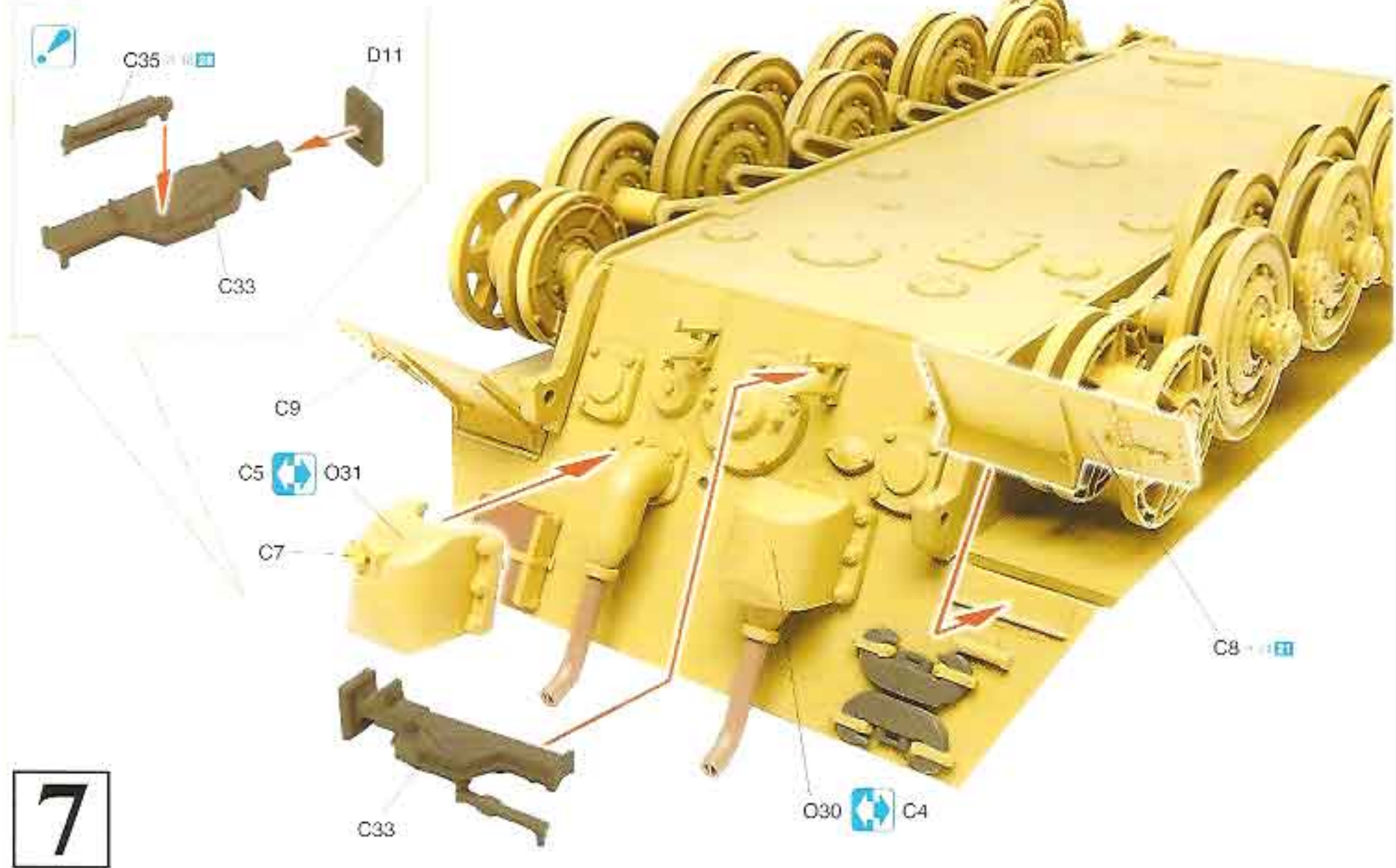

7

8

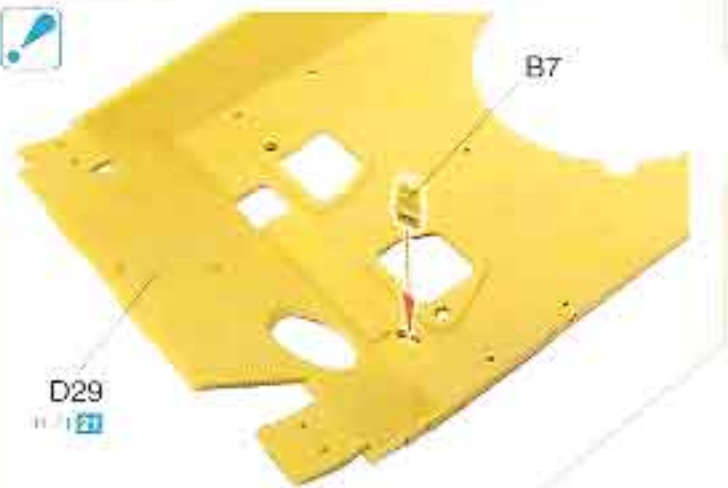

B7

D29

27



C13

D3

28

C14

21

D16

D29

C13

D15

C17

B8

B8

C16

O28

B7

9



10

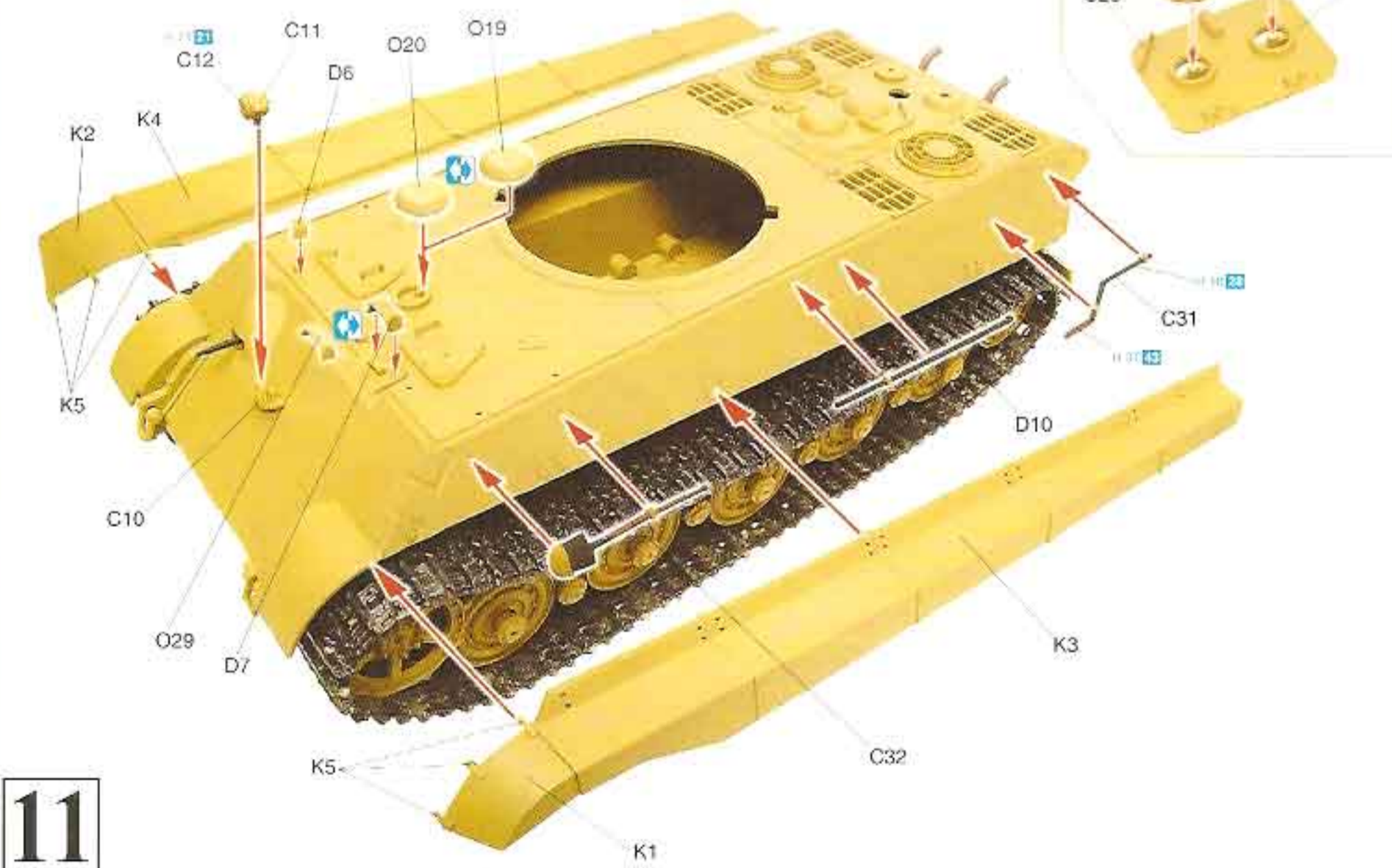
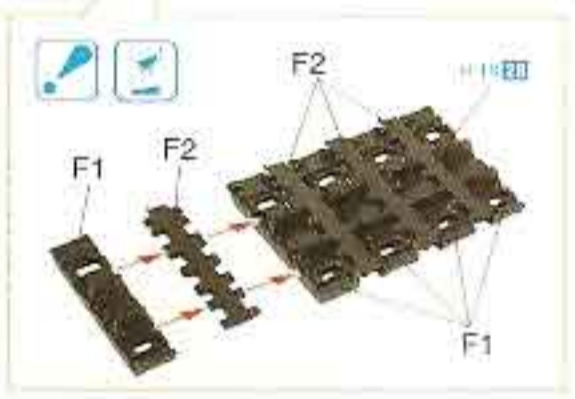

11



12



13

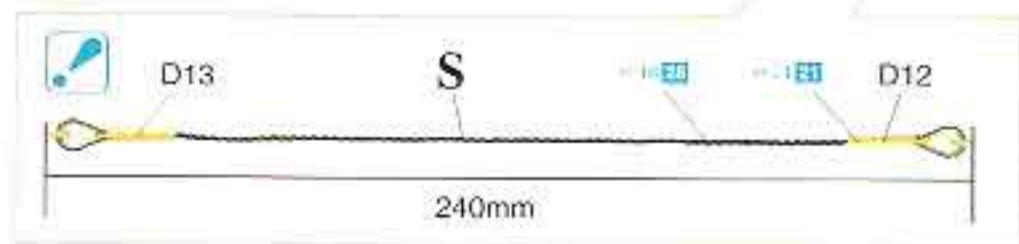
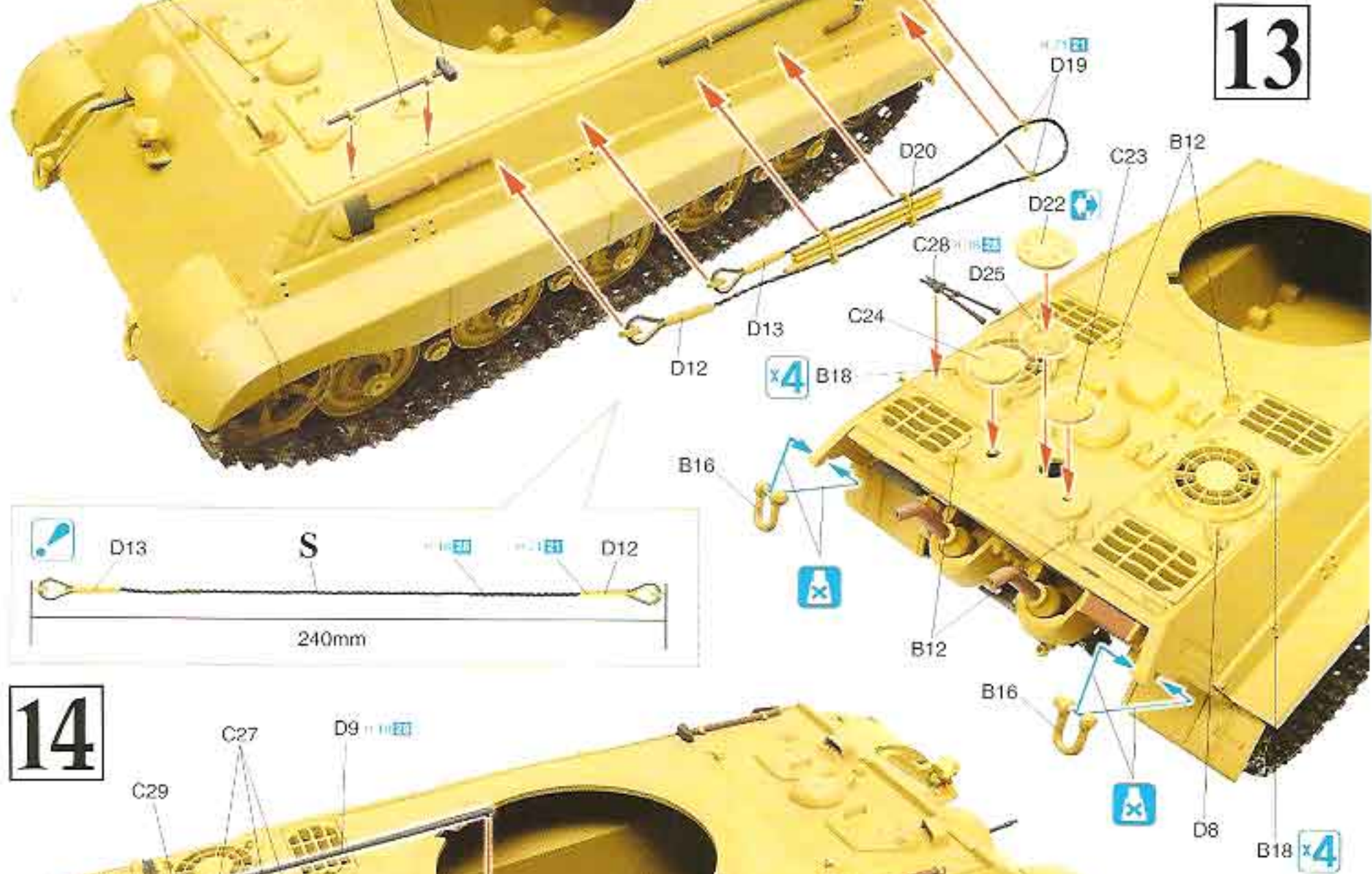

14

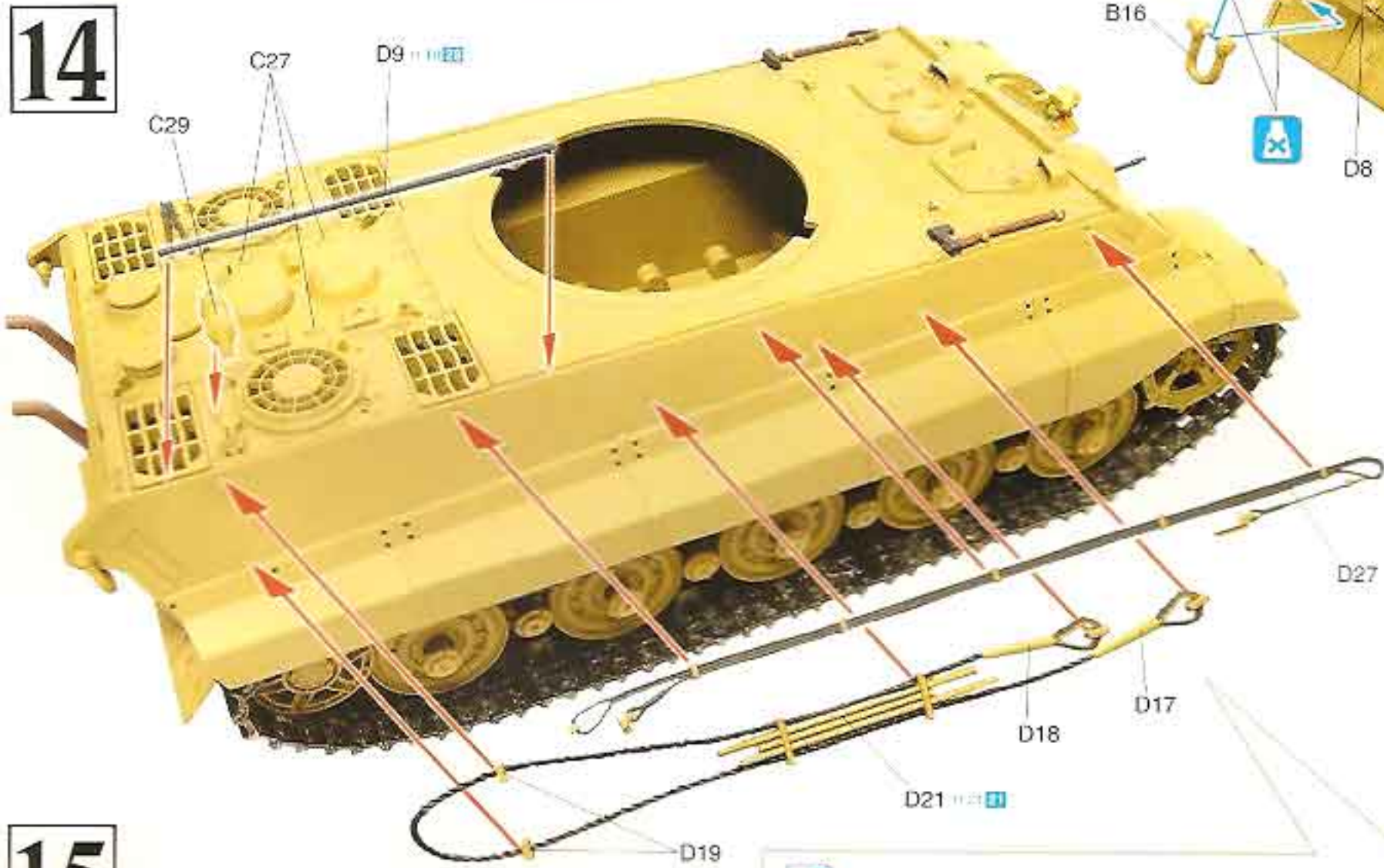

15



15

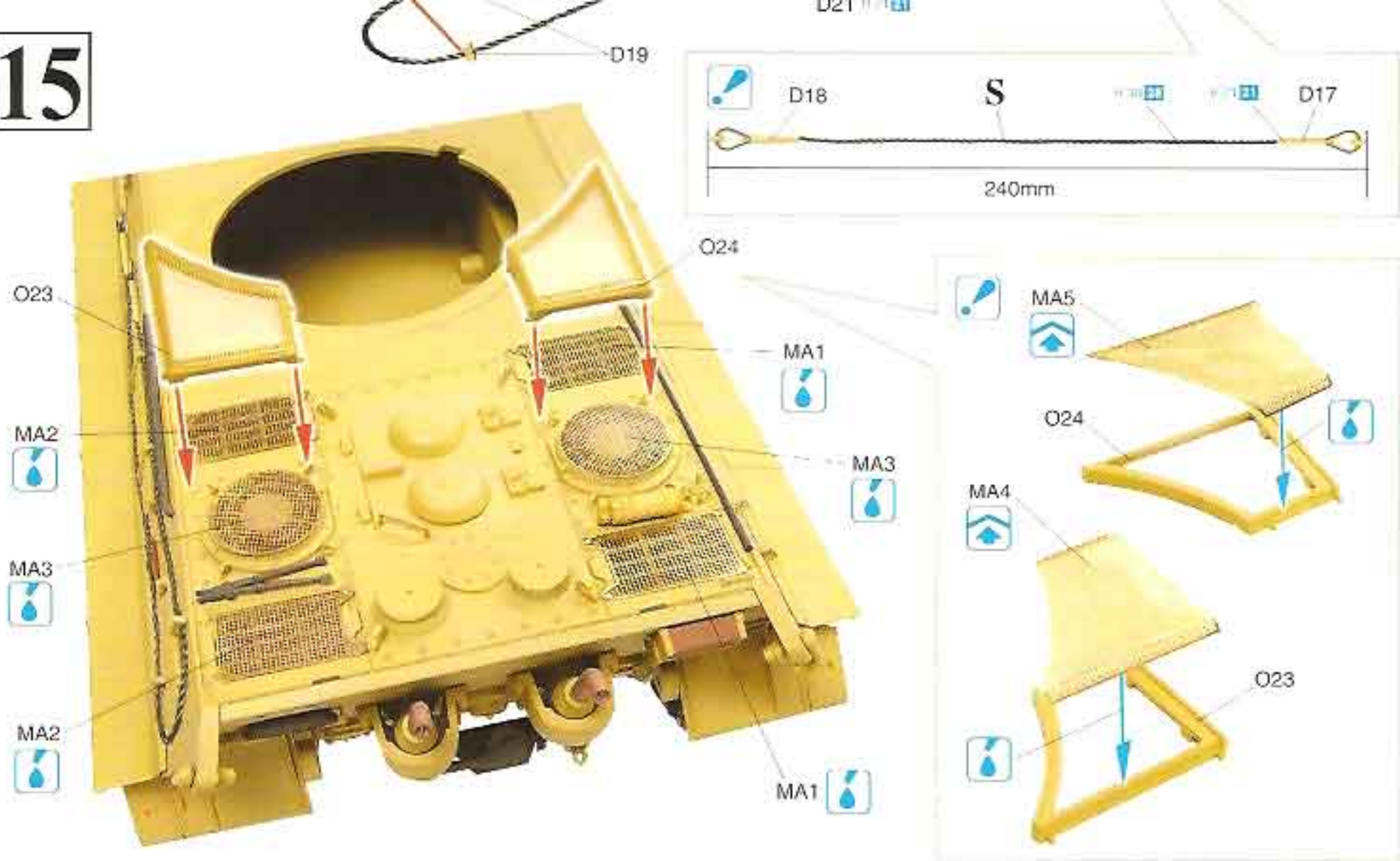

16

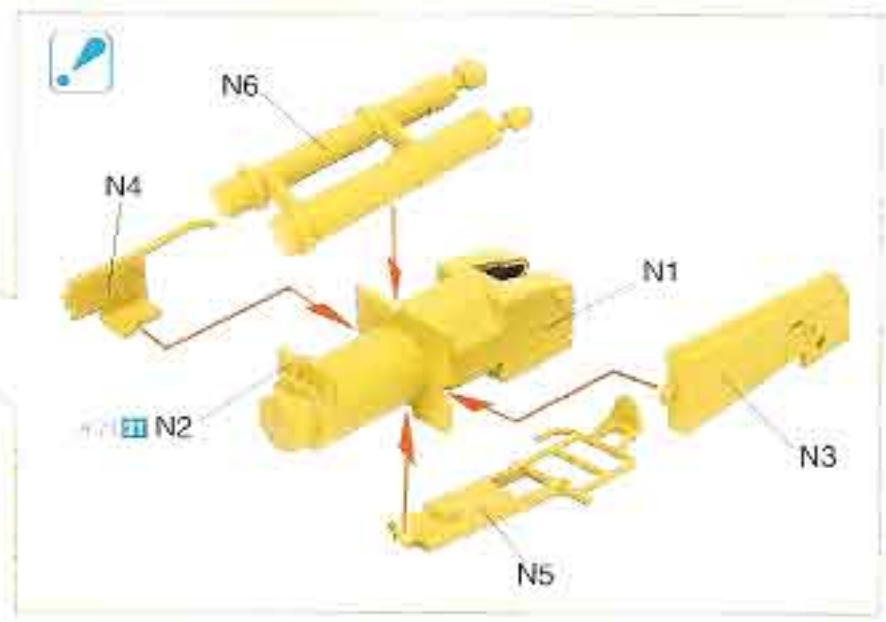
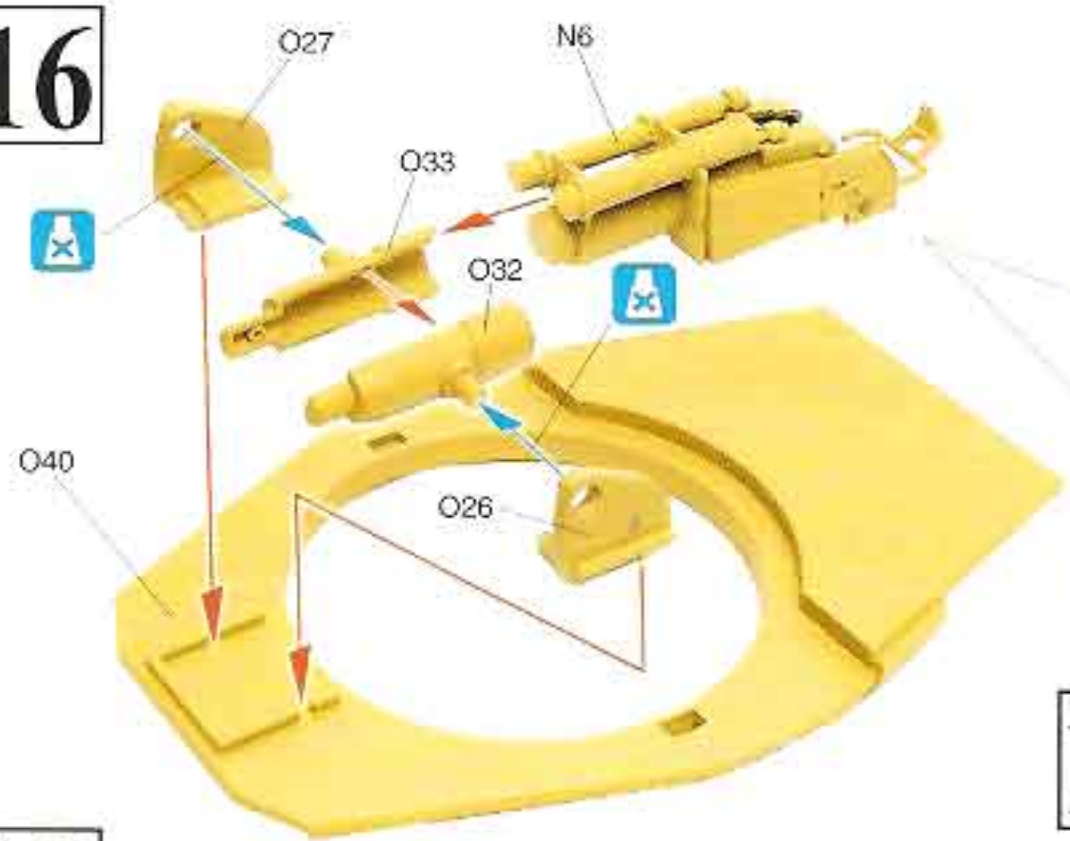

18

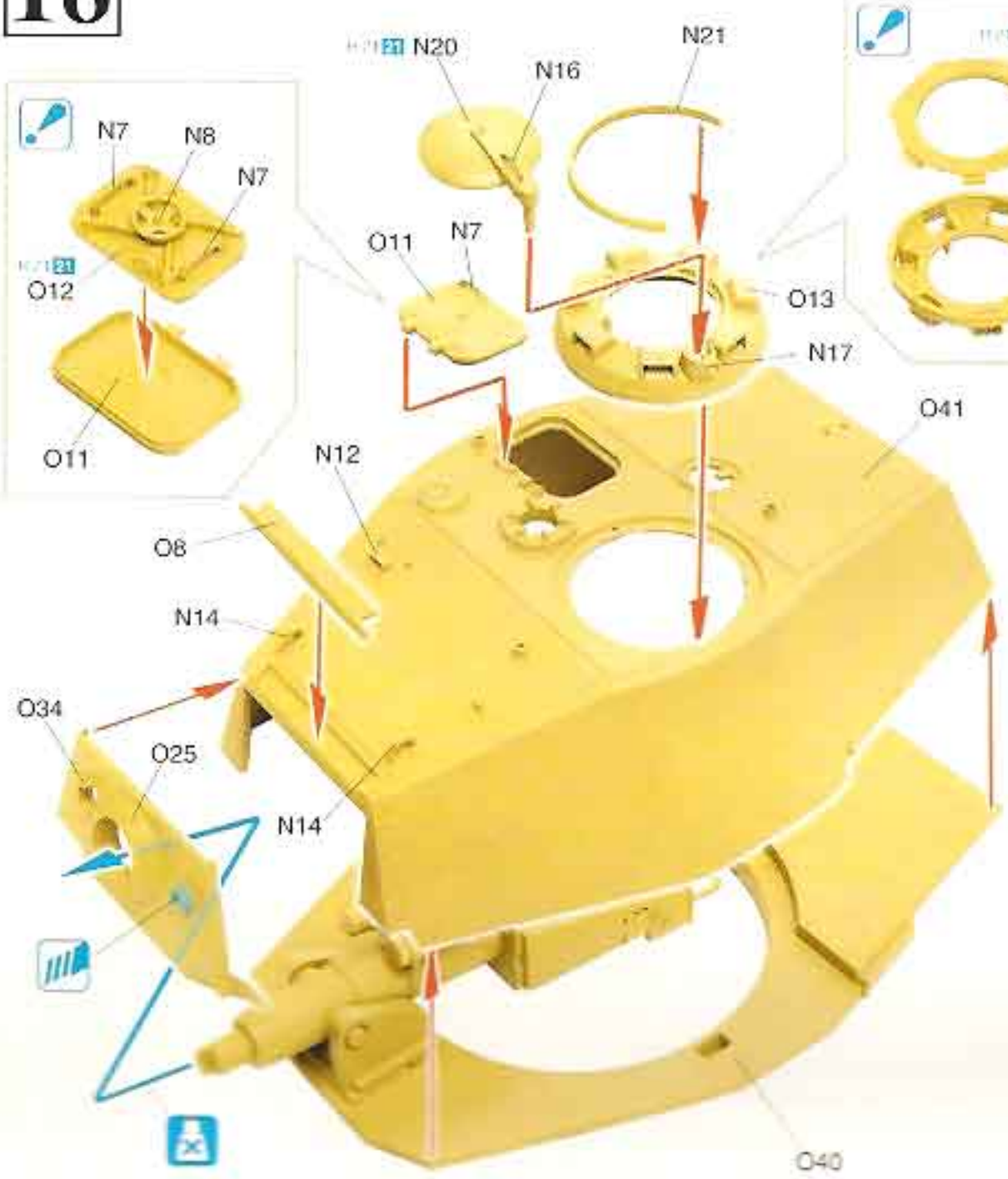

17

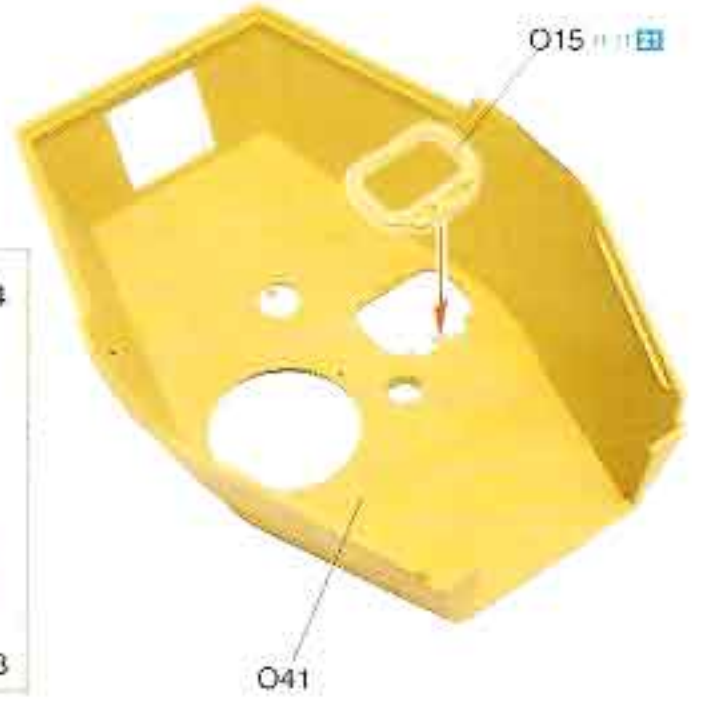



O40

C22

O42



O10

N13

# 19

N11



O35

N14

O5

O1

O41

O36

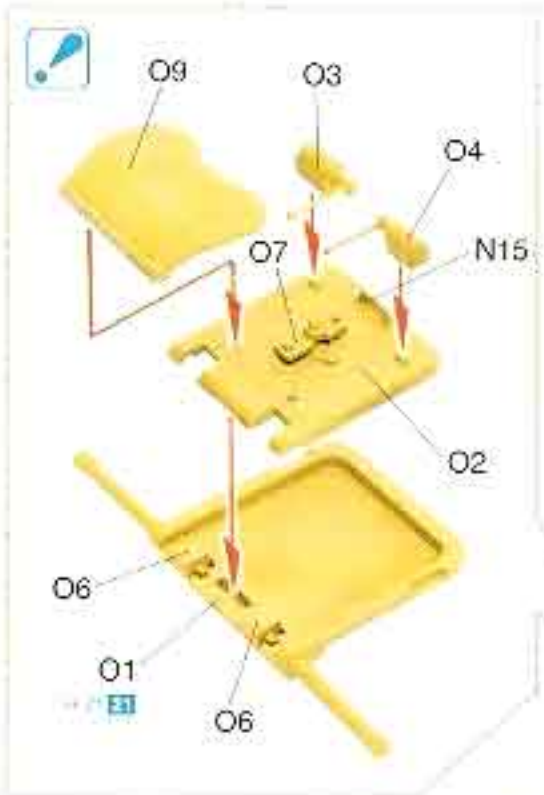

O36

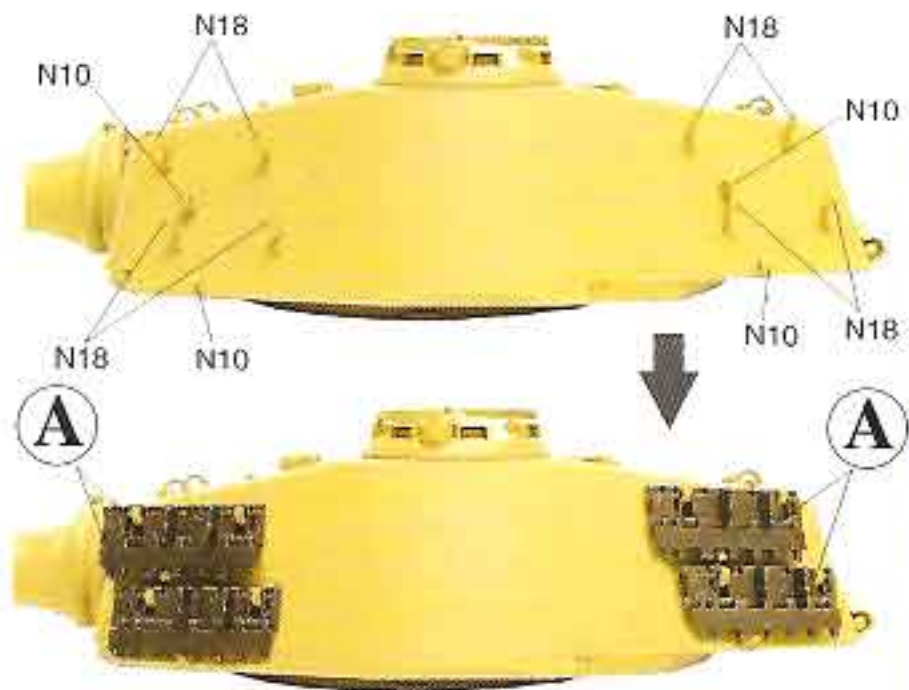
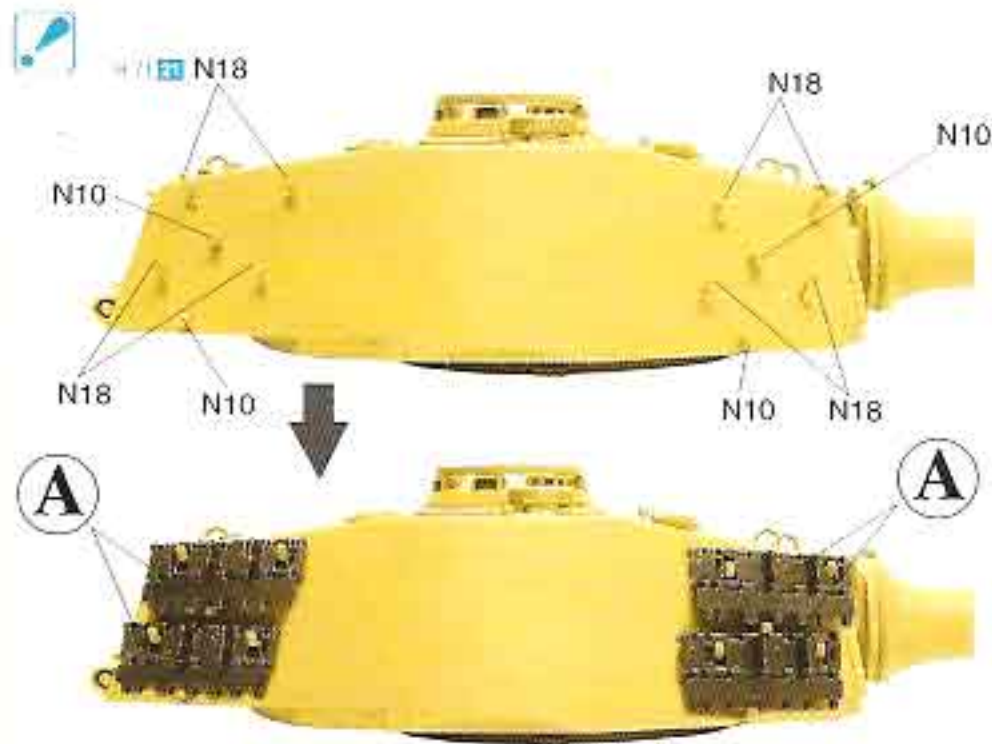
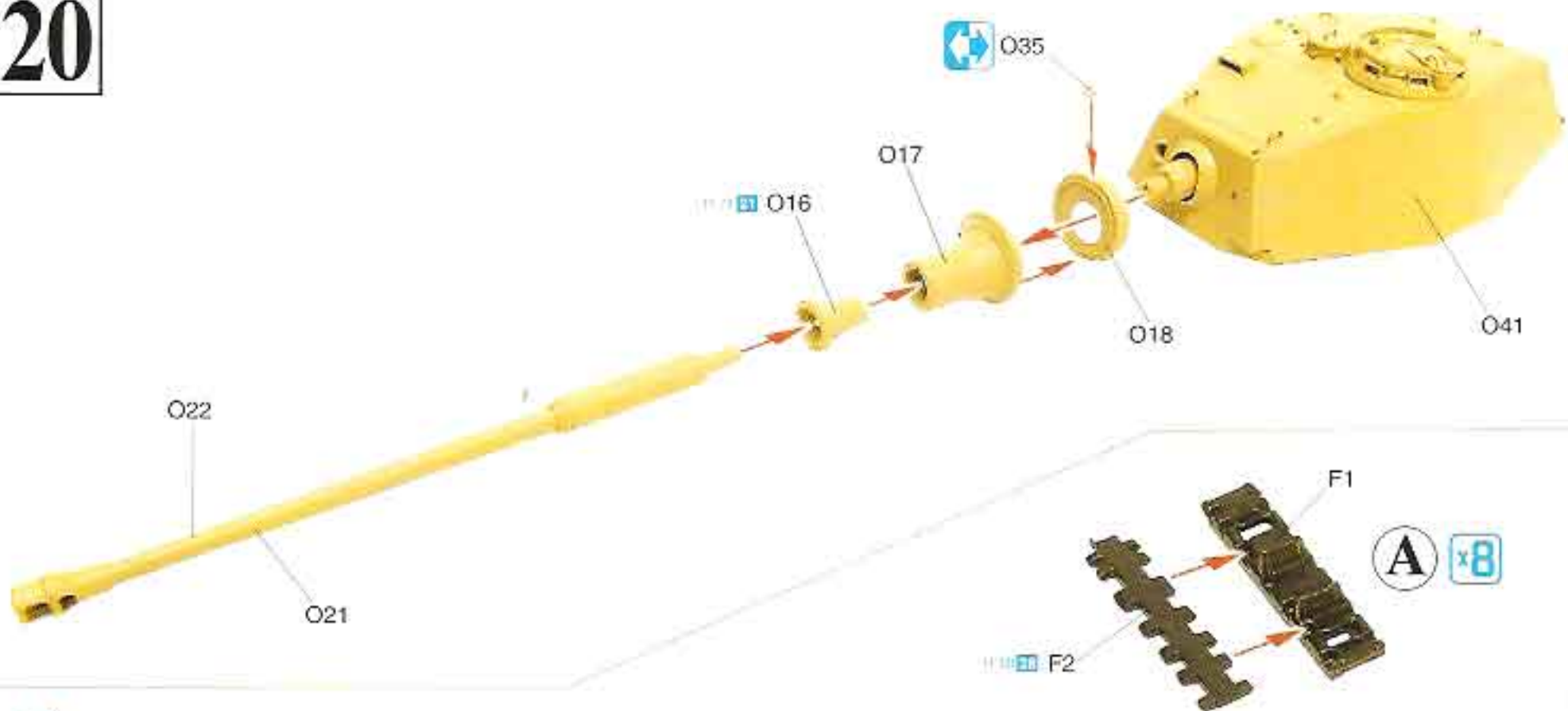

21



# Marking & Painting

マーキング及び塗装図

Markierungen und Bemalung

Decorazioni et Pitture

Marchio & Pittura

標貼及着色指示

## sPzAbt 505, Russia 1944



## sPzAbt 501, Ardennes 1944



